

# SWIMMING POOL HEAT PUMP



## Model ZWPA / ZWPT

### INSTALLATION AND USER'S MANUAL

05022014RM

This manual is valid for all ZWPA / ZWPA swimming pool heat pumps.

Dear customer,

In order to have more ease of the remote control of your pool heat pump, we advise you to place the LED display with the mounting bracket by using the extension cable (11 meter) in a shady place. For example next to the pool control.

Beste klant,

Om nog meer bedieningsgemak van de afstandsbediening van uw zwembadwarmtepomp te hebben, adviseren wij u om de LED display met de bijgeleverde verlengkabel (11 meter) met de montagehouder te plaatsen op een schaduwrijke plaats. Bijvoorbeeld naast de pool control.

Sehr geehrter Kunde,

Um mehr Leichtigkeit der Fernbedienung Ihres Pool Wärmepumpe zu haben, empfehlen wir, die LED-Anzeige mit der Halterung mit dem mitgelieferten Verlängerungskabel (11 Meter), in einem schattigen Ort platzieren. Zum Beispiel neben dem Pool Kontrolle.

Cher

client,

Afin d'avoir plus d'aisance de la télécommande de votre pompe à chaleur de piscine, nous vous conseillons de placer l'écran LED avec le support de montage en utilisant le câble de rallonge (11 mètres) dans un endroit ombragé. Par exemple en regard de la commande de la piscine.

# ZWEMBAD WARMTEPOMP

Dear customers, please read this instruction carefully before the installation and application of this product, otherwise it may lead to damage to the instrument or operators as well as financial loss. When you might need further information please contact your local distributor. With the gradual advancement of science and technology, the product series and specifications will change as well, so you are invited to keep up with the latest products. In reading this instruction, if you need any technical consultations, contact your local distributor.

## ATTENTION:

- √ In selecting the heat pump water heater unit to install, check whether the corresponding power supply agrees with the specifications for heat pump water heater unit power, For detail, refer to the tag on the unit or the installation and operation instruction.
- √ Make sure electricity leakage protection equipment is installed properly according to the regulations and guidelines valid in your area. If you're not sure please contact a professional electrician.
- √ The water heater unit must be reliably ground. It is forbidden to use this unit with no reliable grounding. It is forbidden to connect the ground wire to the zero line or running water pipes.
- √ In wire connection, the electrician must refer to the connection map and wiring diagrams, which can be found in the back of this manual.
- √ For safety, do not change or repair the heat pump water heater unit without permission. If necessary to make any adjustments you should always contact your local distributor before adjustment.
- √ It is forbidden to insert any tools into the heat pump unit in case it may touch the fan to damage the unit or lead to accidents (especially for children).
- √ Hot water with a temperature of more than 52°C can lead to burns. Therefore, only when the hot water in water tank combines with cold water can it be used.
- √ Do not use the water heater unit with the grid or plate work removed in case it may lead to any accidents or abnormal operation of the unit.
- √ If the unit is soaked by water, contact immediately with our factory or its service department. The unit can be reused only after check and solution by the technical staff.
- √ Unqualified technical staff are not allowed to adjust the switches, valves or controllers in the unit.



## CONTENTS:

Description	Page
<b>Chapter 1: General Information</b>	
1.1 Performance and features	6
1.2 Working principles	6
1.3 Technical specifications of the heat pump	7
<b>Chapter 2: Installation</b>	
2.1 Installation of the swimming pool heat pump	9
2.2 Dimensions of the swimming pool heat pump (9.5 – 21.0 kW)	11
2.3 Dimensions of the swimming pool heat pump (26 kW)	11
2.4 Location of the heat pump	12
2.5 Distance from the pool	13
2.6 Installation of the check-valve	13
2.7 Pool system set-up	14
2.8 Installing the pipings and by-pass	15
2.9 Electrical Hook-Up	16
<b>Chapter 3: Start-up</b>	
3.1 Starting up the heat pump	17
3.2 On/off release of the heat pump	18
3.3 Balancing the flow with the by-pass	19
<b>Chapter 4: Controlling the heat pump</b>	
4.1 Operating the LED controller	20
4.2 Power on the heat pump	21
4.3 How to set the working mode	21
4.4 How to set the desired water temperature	22
4.5 How to check and set the parameter values	22
4.6 How to set the clock	22
4.7 Parameter table	23
4.8 How to set the timer on/off function	24
4.9 How to cancel the timer settings	24
4.10 How to (de)block the controller	24
<b>Chapter 5: Protection systems</b>	
5.1 Built-in protections of the heat pump	25
5.2 Swimming pool water chemistry	26
<b>Chapter 6: Maintenance and inspection</b>	
6.1 Winterizing the swimming pool heat pump	27
6.2 Restarting the heat pump after winter	27
6.3 Check-up	28
6.4 Maintenance	28
<b>Chapter 7: Troubleshooting</b>	
7.1 Troubleshooting	29
7.2 Failure codes table	31
<b>Chapter 8: Wiring Diagrams</b>	
8.1/8.2 Wiring diagrams of 1-phase 220/240V units	33
8.3/8.4 Wiring diagrams of 3-phase 380/400V units	35

### 1.1 Performance and features

- √ With a COP value up to 5.0 our heat pumps are very efficient when transferring heat from the air to the swimming pool water. You can save as much as 80% of cost compared to an electrical heater.

- ✓ The heat exchanger is made of PVC and Titanium tube, which can withstand and prolong exposure to swimming pool water.
- ✓ The unit is very easy to operate: simply switch it on and set the desired pool water temperature. The system includes a micro-computer controller, allowing all operation parameters to be set. Operation status can be displayed on the controller with LED display.

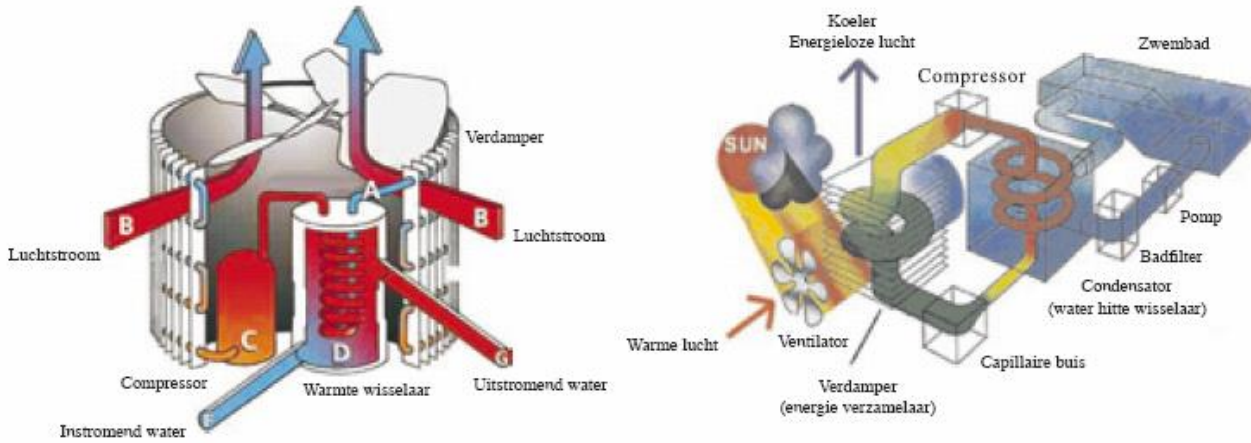

## 1.2 Working principles

- ✓ Heat pumps utilize the sun's free heat by collecting and absorbing energy from the outside air. This energy is then compressed and transferred to the pool water. Your existing water pump circulates the water through the heater, usually next to the pool equipment, and the water warms up. The heat pump timer could be set to operate during daylight hours, for example, usually 9am to 5pm.
- ✓ The unit contains a fan that draws in outside air and directs it over the surface of the evaporator (energy collector). The liquid refrigerant within the EVAPORATOR coil absorbs the heat from the outside air becomes a gas.
- ✓ The warm gas in the coil passes through the COMPRESSOR concentrating and increasing the heat to form a very hot gas which then passes to the CONDENSER (water heat exchanger). It is here that the heat exchange occurs as the hot gas gives off heat to the cool swimming pool water circulating through the coil.
- ✓ The pool water becomes warmer, and the hot gas cooling as it flows through the CONDENSER coil returns to its liquid form and, after passing on through the CAPILLARY TUBE, the whole process begins again.
- ✓ The state of the heat pump technology can efficiently collect heat from the outside air down to the 7°C to 10 range. For tropic and subtropical climates, this means that the pool can be maintained at 26°C to 32°C.

### 1.3 Technical specifications of the swimming pool heat pump (220-240V)

	Model		ZWPA7.8H1F	ZWPA9.5H1F	ZWPA12.5H1F	ZWPA17.0H1F
	Behuizing		ABS kunststof	ABS kunststof	ABS kunststof	ABS kunststof
	Uitblaasrichting		horizontaal	horizontaal	horizontaal	horizontaal
Meetcondities luchttemp. 24°C watertemp. 26°C	Verwarmingcapaciteit	kW	7,8	9,8	12,8	17
	Opgenomen vermogen	kW	1,44	1,73	2,36	3,15
	Bedrijfsstroom verwarmen	A	6,57	7,85	10,72	14,31
	COP		5,4	5,65	5,45	5,4
Meetcondities luchttemp. 15°C watertemp. 26°C	Verwarmingcapaciteit	kW	6,3	7,8	10,2	13,6
	Opgenomen vermogen	kW	1,40	1,65	2,27	3,02
	Bedrijfsstroom verwarmen	A	6,36	7,51	10,33	13,74
	COP		4,5	4,72	4,5	4,5
	Mogelijkheid tot koelen		ja	ja	ja	ja
	Afzekering (traag)	A	16	16	16	16
	Voeding	V/Ph/Hz	220-240/1/50	220-240/1/50	220-240/1/50	220-240/1/50
	Compressor		Rotatief	Rotatief	Rotatief	Scroll
	Ventilator snelheid	RPM	750	750	750	750
	Geluidsdruk 1)	dB(A)	46	46	47	48
	Werkingsgebied	°C	-10/40	-10/40	-10/40	-10/40
	Koelmiddel		R410A	R410A	R410A	R410A
	Warmtewisselaar		Titanium/PVC	Titanium/PVC	Titanium/PVC	Titanium/PVC
	Stromingschakelaar		Sika	Sika	Sika	Sika
	Leiding diameter	mm	50	50	50	50
	Water hoeveelheid min/max	m <sup>3</sup> /h	2,2-4,5	2,7-5,5	3,6-7,2	4,9-9,7
	Water drukverlies	Kpa	10	12	12	14
	Apparaat afmeting LxBxH	mm	938x360x581	1140x400x676	1140x400x676	1080x416x708
	Gewicht	kg	59	60	64	85

- If differences are found between the information in this manual and on the name plate of the pump, always follow the data on the product itself.
- 1) Sound pressure dB(A) measured at a distance of 10 meter.

### 1.3 Technical specifications of the swimming pool heat pump (380-415V)

	Model		ZWPT17.0H3P	ZWPT21.0H3P	ZWPT26.0H3P
	Behuizing		ABS kunststof	ABS kunststof	ABS kunststof
	Uitblaasrichting		horizontaal	horizontaal	horizontaal
Meetcondities luchttemp. 24°C watertemp. 26°C	Verwarmingscapaciteit	kW	17,4	21	26
	Opgenomen vermogen	kW	3,15	3,96	4,73
	Bedrijfsstroom verwarmen	A	5,25	6,60	7,88
	COP		5,52	5,3	5,5
Meetcondities luchttemp. 15°C watertemp. 26°C	Verwarmingscapaciteit	kW	13,8	16,8	21
	Opgenomen vermogen	kW	3,02	3,82	4,57
	Bedrijfsstroom verwarmen	A	5,04	6,36	7,61
	COP		4,56	4,4	4,6
	Mogelijkheid tot koelen		ja	ja	ja
	Afzekering (traag)	A	16	16	16
	Voeding	V/Ph/Hz	380-400/3/50	380-400/3/50	380-400/3/50
	Compressor		Scroll	Scroll	Scroll
	Ventilator snelheid	RPM	750	750	750
	Geluidsdruk 1)	dB(A)	48	49	51
	Werkingsgebied	°C	-10/40	-10/40	-10/40
	Koelmiddel		R410A	R410A	R410A
	Warmtewisselaar		Titanium/PVC	Titanium/PVC	Titanium/PVC
	Stromingschakelaar		Sika	Sika	Sika
	Leiding diameter	mm	50	50	50
	Water hoeveelheid min/max	m <sup>3</sup> /h	4,9-9,7	9-14	11-17
	Water drukverlies	Kpa	14	16	16
	Apparaat afmeting LxBxH	mm	1080x416x708	1080x416x960	1080x416x1260
	Gewicht	kg	85	118	152

- If differences are found between the information in this manual and on the name plate of the pump, always follow the data on the product itself.
- 1) Sound pressure dB(A) measured at a distance of 10 meter.



## 2.1 Installation of the swimming pool heat pump

### **Remark:**

The delivery of the pool heat pump only includes the swimming pool heat pump, other necessary parts must be purchased separately.

### **Attention:**

Please follow these steps carefully when installing the heat pump:

- √ The heat pump must always be placed on a firm, flat surface. Always use vibration dampers to avoid vibration and unnecessary noise production.
- √ The heat pump must always remain in upright position (even during transport). It is recommended that the heat pump stands steady for at least 24 hours after transport or movement before you turn on the system.
- √ The heat pump may only be serviced by an authorized installer.
- √ Always use original parts! The use of other parts than the original ones, may lead to efficiency problems and/or damage the unit.

### **Warranty is only applicable when:**

- √ The heat pump is installed in accordance with the guidelines in this manual.
- √ The electrical supply and security components such as circuit breaker and fuses meet the requirements in your local area's guidelines.
- √ The installation meets the hydronic conditions as stated in the technical specifications on page 5.
- √ Placement of the heat pump is in accordance with the terms and conditions on page 8/9
- √ The heat pump is switched in the right way
- √ The heat pump is serviced by a certified technician on a yearly basis
- √ The unit is not exposed to frost

## 2.2 Dimensions of the swimming pool heat pump (7.8 – 21.0 kW)

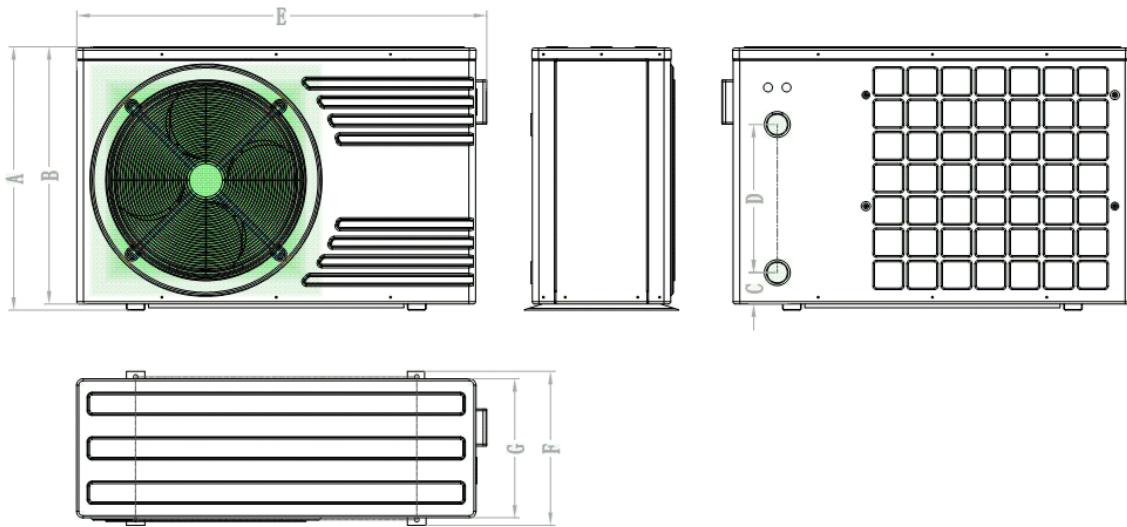

Model	A	B	C	D	E	F	G
ZWPA7.8H1F	584	554	85	250	968	360	313
ZWPA9.5H1F	594	564	85	300	1044	370	340
ZWPA12.5H1F	594	564	85	300	1044	370	340
ZWPA17.0H1F	722	694	85	400	1108	416	386
ZWPT17.0H3P	711	694	85	400	1108	416	386
ZWPT21.0H3P	958	944	85	500	1078	446	420

The above dimensions are given in mm.

### 2.3 Dimensions of the swimming pool heat pump (26 kW)

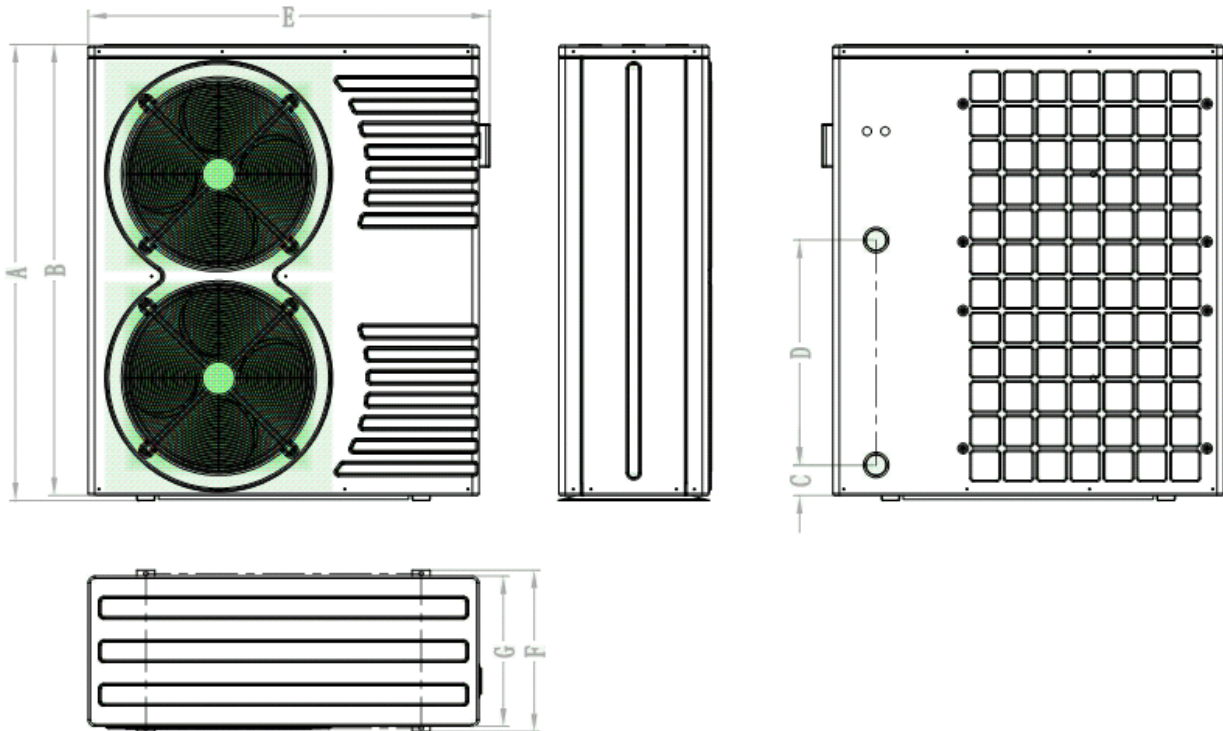

Model	A	B	C	D	E	F	G
ZWPT26.0H3P	1258	1244	85	620	1108	446	420

The above dimensions are given in mm..

## 2.4 Location of the swimming pool heat pump

The unit will perform well on any location provided three factors are present:

1. Fresh air supply
2. Electricity
3. Swimming pool filter piping

The unit may be installed virtually anywhere outdoors providing minimum distance requirements are met with respect to other objects (see diagram below). For indoor pools please consult your installer. If the unit is placed in a windy area, no problems occur with e.g. the pilot light, as opposed to what is often the case with gas heaters.

### **Attention:**

Do not place the unit in an enclosed area with a limited air volume where the unit's discharged air will be re-circulated or near shrubs that could block the air inlet. These locations deny the unit a continuous fresh air supply, which reduces its efficiency and may prevent adequate heat yield. See diagram below for minimum required distances.

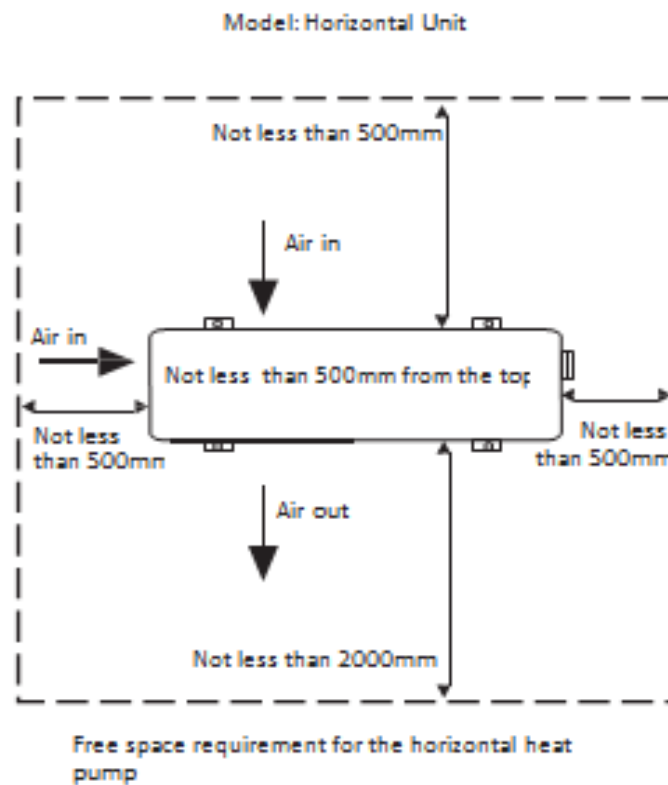

## 2.5 Distance from the pool

Normally, the pool heat pump is installed within a 7.5 meter radius of the pool. The greater the distance from the pool, the greater the heat losses from the piping. Since the piping is buried for the most part, heat

loss is minimal for distances of up to 30 meters (15 meters to and from the pump= 30 meters total), unless the soil is wet or the water level is high. Heat loss per 30 meters could roughly be estimated at 0.6 kw - hour (2000 BTU ) for every 5 °C temperature difference between the pool water and the soil surrounding the pipe, which translates to an operation time increase of 3-5%.

## 2.6 Installation of the check-valve

When using automatic chlorine and PH dosage systems, it is of uttermost importance to protect the heat pump from high concentrations of these chemicals that could corrode the heat exchanger. Therefore, such systems should add the chemicals in the conduits located downstream of the heat pump and it is recommended to install a check-valve in order to prevent backflow when there is no water circulation. Damage to the heat pump caused by disregarding any of these recommendations will invalidate the warranty.

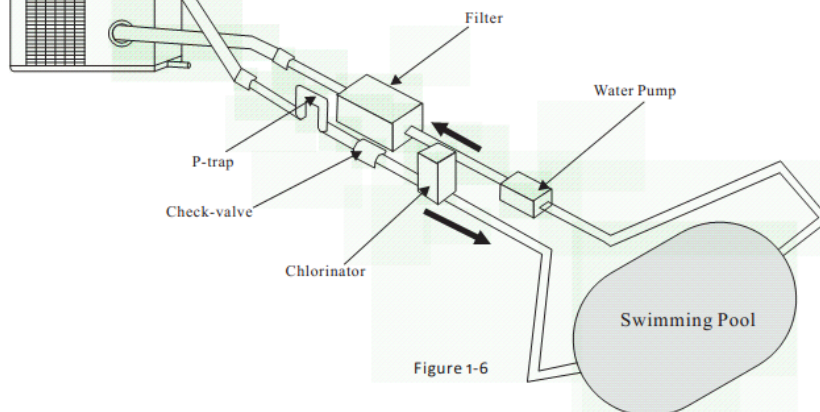
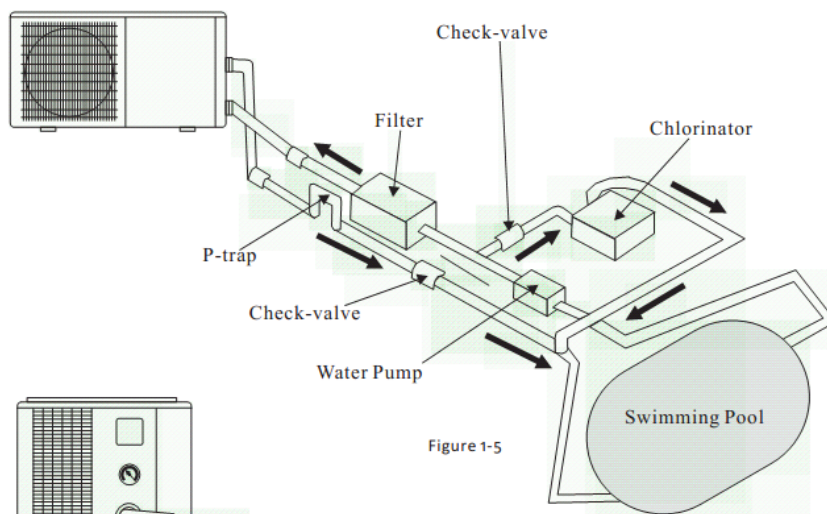

## 2.7 Pool system set-up

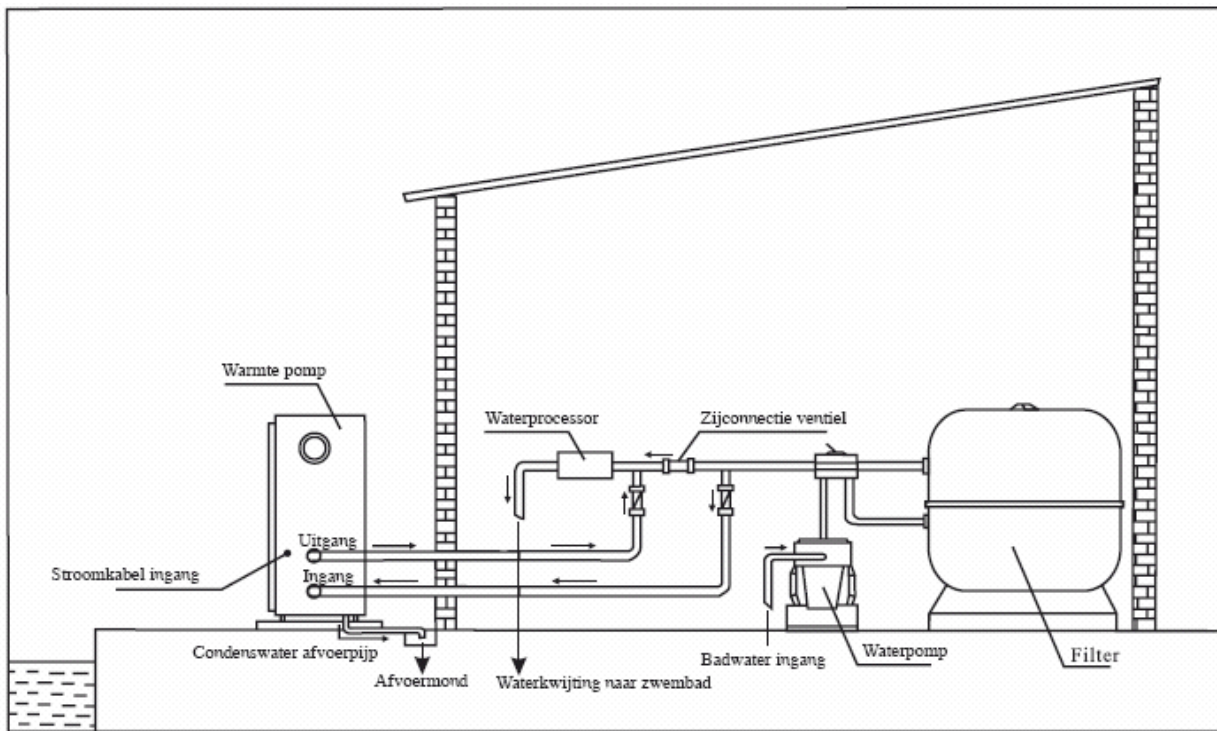

Ensure that the heat pump is installed above the pool level. Please make sure that it is possible for the water to run out of the heat pump automatically when the circulation pump is switched off, because then the flow switch will turn off the heat pump. When the heat pump continues running without any flow it could cause enduring errors and or damage you heat pump.

## 2.8 Connecting the by-pass

In order to regulate the heat pump's water circuit, you must provide a by-pass between the incoming and outgoing connections. Therefore the piping must feature three regulation-valves according to the below diagram.

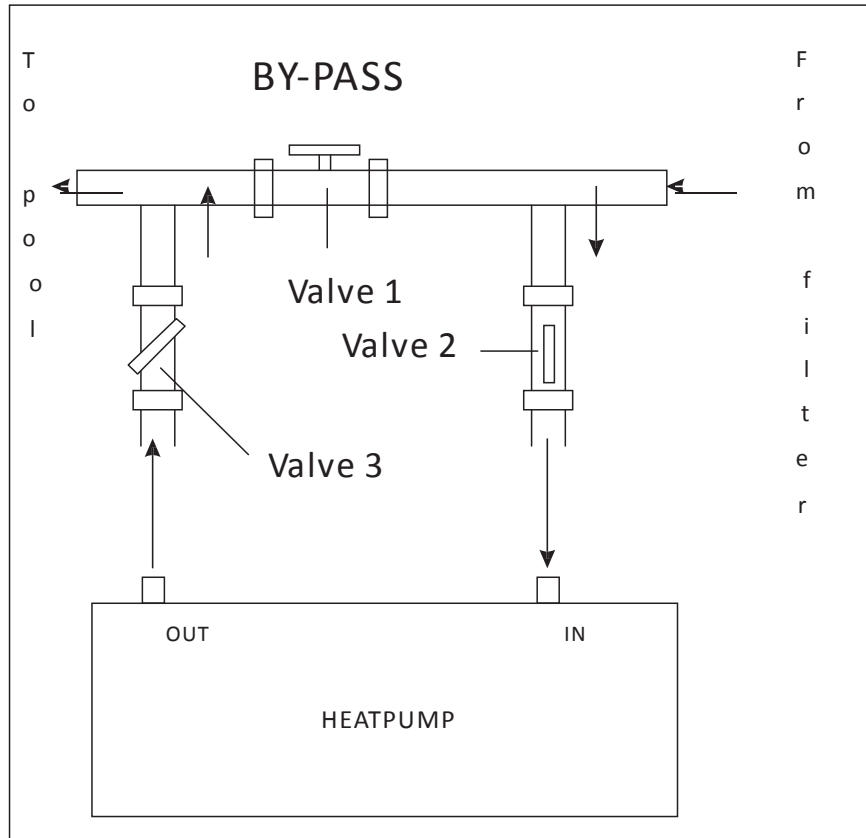

Figure 1-8

## 2.9 Electrical hook-up

### IMPORTANT!

Although the heat pump is electrically isolated from the rest of the unit, this only prevents the passage of electricity to or from the pool water. Grounding the unit is still required to protect yourself from short circuits inside the unit. Please contact a certified electrician to make sure your heat pump is grounded correctly..

For horizontal models (VBK / ZWPT / ZWPA) the electrical connection area is located behind the cover on the right side next to the fan opening.

Connect the electrical wires with the terminal block labelled "Power Supply". Next to this connection, there is a second terminal block labelled "Water Pump", to which the filter pump (max . 5A/240V) can be connected. This connection makes it possible to control filter pump operation with the heat pump. See further at Parameter setting table (Parameter 9) for the different possibilities.



Figure 1-9



Figure 1-10

### Remarks for models with 3 phases:

for models with 3 phases, switching 2 phases may cause in inversion in the rotational direction of electrical motors, which could damage the unit. Therefore, a protection device has been built in, which will interrupt the circuit if the connection has not been performed correctly.

Model	Voltage (V)	Fuse (A) Slow C-curve	Nominal Current(A)	Cable diameter (mm <sup>2</sup> ) Max. length of 15 m.
ZWPA-7.8H1F	220-240	16 traag (C)	7,9	2x2,5 + 2,5
ZWPA-9.5H1F	220-240	16 traag (C)	9,7	2x2,5 + 2,5
ZWPA-12.5H1F	220-240	16 traag (C)	12,7	2x2,5 + 2,5
ZWPA-17.0H1F	220-240	16 traag (C)	14,5	2x4,0 + 2,5
ZWPT-17.0H3P	3 x 380	16 traag (C)	6,4	4x2,5 + 2,5
ZWPT-21.0H3P	3 x 380	16 traag (C)	8,0	4x2,5 + 2,5
ZWPT-26.0H3P	3 x 380	16 traag (C)	9,8	4x2,5 + 2,5



### 3.1 Starting up the heat pump (first-time)

#### Attention!

**In order for the unit to heat the pool (or spa), the filter pump must be running so that the water can circulate through the heat pump. Without this circulation, the heat pump will not start.**

When all connections have been made and checked, you should follow these steps:

- √ Turn on the filter pump. Check for leaks and verify flow to and from the pool.
- √ Turn on the electrical power supply to the unit, then press the ON/ OFF key on the electronic control panel. The unit should start when the time delay period has lapsed.
- √ When the unit has been running for a couple of minutes, check if the air leaving the unit is cooler.
- √ Check the performance of the flow switch as follows: with the unit running, turn the filter pump off. The unit should also switch off automatically. If not, the flow switch must be readjusted.
- √ All the unit and filter pump to run 24 hours a day until the desired pool water temperature is reached. When the set temperature is reached, the unit switches itself off. The unit will now automatically restart (as long as your filter pump is running) when the temperature of the pool water experiences a drop of more than 1°C below the set temperature.

Depending on the starting temperature of the pool water and the air temperature, it can take several days for the water to reach the desired temperature. Covering the pool can drastically reduced this period.

#### Water Flow Switch

The unit is equipped with a flow switch that is switched on when enough water has flowed through the unit and that is switched off when the water flow becomes too low. (For example when the filter pump is switched off).

#### Time delay

The unit is equipped with a built-in 3-minute start delay included to protect electrical components and contacts. After this time delay, the unit will automatically be restarted. Even a brief interruption of the power supply will activate the start delay and prevent the unit from starting immediately. Additional interruptions of the power supply during the delay period will have no effect on the 3-minute countdown.

#### Condensation





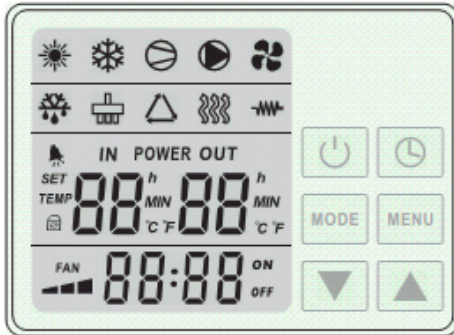

When the swimming pool water is being heated by the heat pump, the incoming air is cooled down quite a bit, which can cause condensation on the fins of the evaporator. Condensed volumes can attain several liters per hour under high atmospheric humidity. Sometimes, this is wrongfully interpreted as a water leak.

## 4.1 Controlling the heat pump with the LED controller















When heat pump is supplied with power, controller will display with full screen, shows that it is already connected. If connection fails in 10 seconds, please check connections between communication cable and control display, or replace with another control display.

### Button functions:

	Turns the heat pump on or off
	Timer button to set timer on and timer off
<b>MENU</b>	Gives access to the parameter list and is used to confirm settings
<b>MODE</b>	To set the desired working mode: heating, cooling or auto mode
 	To decrease  or increase  value

### LED display icon definition:

	heating icon, showing heat pump is in heating mode
	cooling icon, showing heat pump is in cooling mode
	auto icon, showing heat pump is in auto mode
	compressor icon, showing compressor status
	water pump icon, showing water pump status
	fan icon, showing fan status
	defrost icon, showing defrost status
	four way valve icon, showing four way valve status
	electric heater icon, showing if external electric heater is activated or not.
	electric heater running icon, showing electric heater is running or not
	alarm icon, showing system alarm
	fan speed icon, showing high (3), medium(2) and low(1) fan speed
	key pad lock icon, showing buttons on the control display are locked.

### Remark:

1. Heat pump is not equipped with electric heater internally, only provides terminal for external connection.
2. Fan speed is automatically controlled by ambient temperature, not manually.

## 4.2 How to power the heat pump on or off?

Press  button to switch on the heat pump.

Once the heat pump is powered on all related running component icons will be lightened as well as POWER displayed in the middle of display to show system is in running status.

Figure 2-2 shows heat pump in standby status and figure 2-3 shows heat pump in running status. The left temperature shows flow water temperature while the right temperature is the return water temperature.

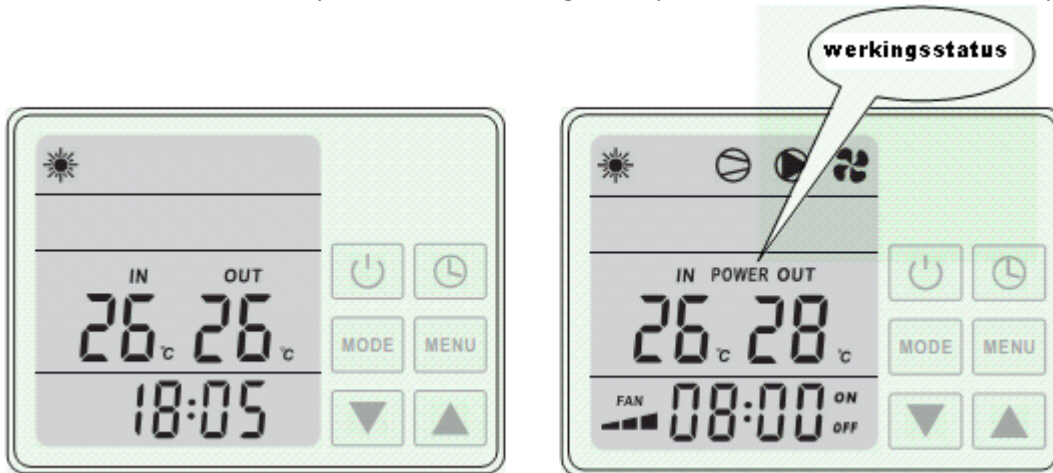

## 4.3 How to change the working mode

Press MODE button to select auto, heating or cooling mode, related indicator icon will be lightened as a symbol to show the heat pump is in either auto, heating or cooling mode.

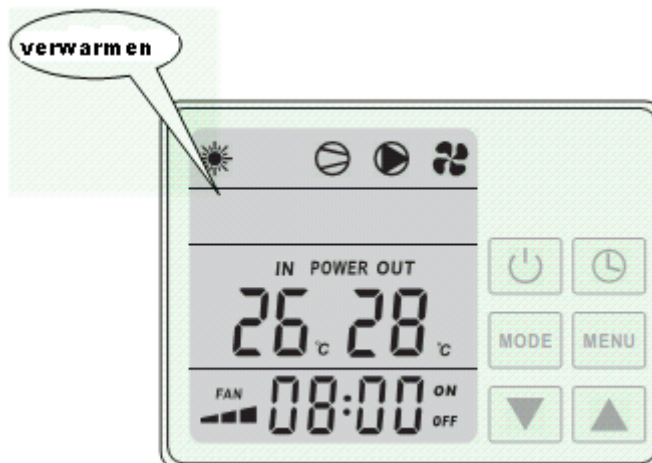

## 4.4 Adjust desired water temperature

1. First select the desired mode; auto, heating or cooling.
2. Then use the arrow buttons to increase or decrease the set value. The LED display will show the set value.

## 4.5 How to check and set the parameters

1. Press "MENU" button for 5 seconds. The Parameter number and value will start flashing together on the LED display.
2. Use the arrow buttons to navigate to the required parameter number.
3. Press the "MENU" button to choose the required parameter. The parameter number stays fixed, while the value will continue to flash.
4. Use the arrow buttons to set the desired value for the chosen parameter. You can press the MENU button to confirm the settings. Without any further movement on the display buttons in 5 seconds it will return to the main interface automatically.

### ATTENTION!

You can always enter the parameter list and check the values, but the set values can only be changed when the heat pump is in standby status.

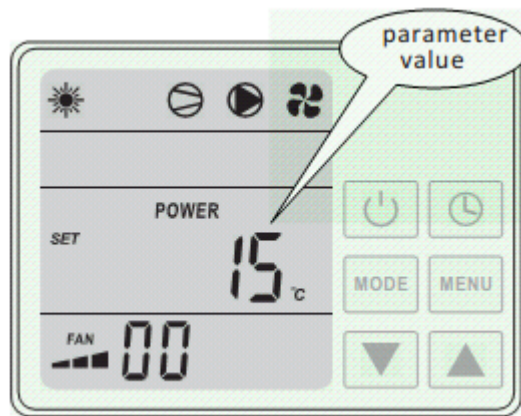

## 4.6 Setting the time

1. Press MENU button in a quick stop to activate time setting
2. The hour numbers start flashing, adjust them with the arrow buttons
3. Press MENU button to confirm the hour setting
4. The minute numbers start flashing, adjust them by using the arrow buttons
5. Press MENU button to confirm the minutes setting
6. The LED display will return to the main interface



## 4.7 Parameter Table

Parameter	Omschrijving	Range	Default	Remark
0	Desired water temperature in cooling mode	8 – 37 °C	28 °C	End User (page. 20)
1	Desired water temperature in heating mode	5 – 40 °C	28 °C	End User (page. 20)

2	Defrosting cycle	30 – 90 min	45 min	Adjusted by Technicians
3	Coil temperature set point to start defrosting	-30 – 0 °C	-7 °C	Adjusted by Technicians
4	Coil temperature set point to stop defrosting	2 – 30 °C	13 °C	Adjusted by Technicians
5	Maximum duration for defrosting	1 – 15 min	8 min	Adjusted by Technicians
6	System quantity of compressors	1 – 2	1	Adjusted by Technicians
7	Restart after power failure (1=yes, 0=no)	0 – 1	1 (yes)	Adjusted by Technicians
8	Mode lock: 0 = cooling only 1 = heating and cooling 2 = heating, cooling and external electrical heater 3 = heating only	0 – 3	1	Adjusted by Technicians
9	Working mode of water pump: 0 = water pump is always on 1 = water pump is only running when the heat pump is switched on	0 – 1	0	Adjusted by Technicians
10	Desired water temperature in automatic mode	8 – 40 °C	40 °C	Adjusted by Technicians
11	Hysteria	1 – 10 °C	2 °C	Adjusted by Technicians
12	Low pressure switch detection: 0 = default protection 1-2 = delayed protection, only to be set by manufacturer	0/1/2	0	Adjusted by manufacturer
A	Actual inlet water temperature	-9 – 99 °C		Measured value
B	Actual outlet water temperature	-9 – 99 °C		Measured value
C	Coil temperature in system 1	-9 – 99 °C		Measured value
D	Coil temperature in system 2	-9 – 99 °C		Measured value
E	Ambient temperature	-9 – 99 °C		Measured value

**Attention! For the ZWPA/ZWPT heat pumps Parameter 6 always has to be set to 1 compressor!**

## 4.8 Setting Timer On and Time Off

- √ Press  button to enter timer setting
- √ Hour data will be flashing with ON. Use the arrow buttons to set the desired hour.
- √ Confirm the Timer On setting by pressing the  button.
- √ Minute data starts flashing once hour setting is confirmed. Use the arrow buttons to set the desired minutes.
- √ Confirm the set minutes by pressing the  button
- √ The heat pump will switch on at the set time

Once Timer On is set and confirmed, Timer Off will be activated. Follow the above steps to set the Timer Off time.

## 4.9 Cancelling Timer On and Timer Off

- ✓ Press the  button to activate, time and ON /OFF starts flashing together.
- ✓ Press **MENU** button to cancel the timer and ON/ OFF icons will disappear on the display.

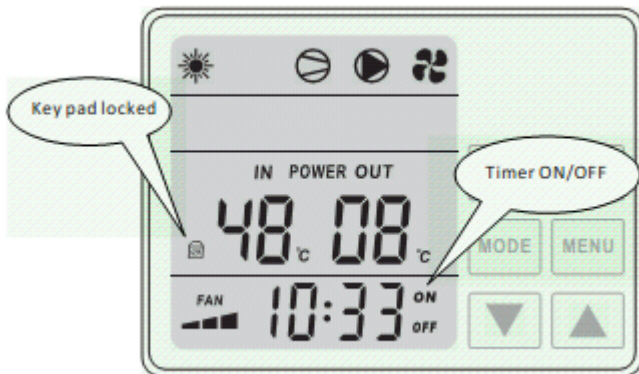

## 4.10 How to lock the LED controller's key pad?

Press both arrow buttons together for 5 seconds, display will show lock icon.  
Do this again to unlock.

## **5.1 Protection systems**

### **Water flow switch**

Equipped with flow switch the heat pump will not work when the filter pump is not working (and the water is not circulating). This system prevents the heat pump from heating only the water present in the heat pump itself. The protection also stops the heat pump if water circulation is cut off or stopped.

### **Refrigerant gas high and low pressure protection**

The high pressure protection makes sure the heat pump is not damaged in case of over pressurisation of the gas. The low pressure protection emits a signal when refrigerant is escaping from the conduits and the unit can not be kept running.

### **Overheating protection on the compressor**

This protection protects the compressor from overheating.

### **Automatic defrost control**

When the air is very humid and cold, ice can form on the evaporator. In that event, a thin layer of ice appears that will grow increasingly bigger as long as the heat pump is running. When the temperature of the evaporator has become too low, automatic defrost control will be activated, which will reverse the heat pump cycle so that hot refrigerant gas is sent through the evaporator during a brief period of time to defrost it.

### **Temperature difference between inflowing and outflowing water**

During normal operation of the heat pump, the temperature difference between inflowing and outflowing water will approximate 1 to 2°C. In the event that the pressure switch does not work and that the water stops circulating, the temperature probe monitoring the outflowing water will always detect a rise in temperature. As soon as the temperature difference between inflowing and outflowing water exceeds 13°C, the heat pump will be automatically turned off.

### **Low temperature cut-out**

If, during cooling, the temperature of the outflowing water reaches 5°C or drops below this temperature, the heat pump will turn itself off until the water temperature reaches or exceeds 7°C again.

## Anti-frost protection during winter

This protection can only be activated if the heat pump is in STAND-BY status.

### First anti-frost protection (switching external water filter pump)

If the filter pump is controlled by the heat pump (regardless of the value for parameter 9) and when the water temperature lies between 2 and 4°C, and the air temperature is lower than 0°C, the filter pump will be automatically turned on to prevent the water from freezing in the piping. This protection is deactivated when the temperature rises again.

### Second anti-frost protection

If the water temperature drops even more, that is, below 2°C (during long frost periods), the heat pump will also start running to heat the water until its temperature approximates 3°C. When this temperature is reached, the heat pump will stop, but anti-frost protection will remain active until conditions change.

### ATTENTION!

The first anti-frost protection is only available when the external water pump is switched by the heat pump. If the external water pump is not operated by the heat pump it should always be on.

## 5.2 Swimming pool water chemistry

Special attention should be paid to the chemical balance of the pool water. The pool water values should always stay within the following limits:

	Min	Max
pH	7.0	7.4
Chloor (mg/l)	0.5	1.2
TAC (mg/l)	80	120
Zout (g/l)		3

**Important: failure to comply with these limits will invalidate the warranty.**

***Note: exceeding one or several limits can damage the heat pump beyond repair. Always install water treatment equipment past the heat pump's water outlet, especially if the chemicals are automatically added to the water. A check-valve should also be installed between the outlet of the heat pump and this equipment in order to prevent products from flowing back into the heat pump if the filter pump stops.***



## 6.1 Heat pump winterizing

**Important: failure to take the necessary precautions for winterizing can damage the heat pump, which will invalidate the warranty.**

The heat pump, filter pump, filter and conduits must be protected in areas where the temperature can drop below the freezing point, Evacuate all water from the heat pump as follows:

- √ Interrupt the electrical power supply to the heat pump
- √ Close the water supply to the heat pump
- √ Completely close valves 2 and 3 of the by-pass
- √ Disconnect the water inlet and outlet coupler fittings of the heat pump and let the water drain out of the unit.
- √ Loosely reattach water inlet and outlet coupler fittings to the heat pump in order to prevent dirt from setting into the conduits.

## 6.2 Restarting the pump after winter

If you purged your heat pump for winterizing, you should undertake the following steps to restart it in spring:

- √ Check first if there is no dirt in the conduits and if there are no structural problems
- √ Check if the water inlet and outlet coupler fittings are adequately fastened to the heat pump
- √ Start the filter pump to start the water flow to the heat pump. Set the by-pass again
- √ Reconnect the electrical power supply to the heat pump and turn it ON.

## 6.3 Check-up

Our heat pumps have been developed and built to last, that is, if they have been installed correctly and can run under normal conditions. Regular check-ups are important if you want your heat pump to function safely and efficiently for years on end.

- √ Make for easy access to the service panel
- √ Keep the area surrounding the heat pump free of contingent organic waste
- √ Prune the vegetation near the heat pump so that there is enough free space around the pump
- √ Remove contingent water sprinklers from the vicinity of the heat pump. They can damage the heat pump.
- √ Prevent rain from directly running off a roof onto the heat pump. Install proper drainage
- √ Do not use the heat pump if it has been flooded. Immediately contact a qualified technician to inspect the heat pump and repair it if should prove necessary

Condensation can occur when the heat pump is running. This condensation can flow away through an opening in the base pan of the unit. The amount of condensation water will increase when atmospheric humidity is high. Remove any dirt that could possibly hamper the evacuation of condensation. 10 to 20 litres of condensation water can be produced while the unit is running. If more condensation is produced, stop the heat pump and wait for one hour before checking for leaks in the conduits.

Note: a quick way to verify that the water running through the condensation drain is indeed condensation, is to shut off the unit and keep the pool pump running. If the water stops running out of the condensation drain, it is condensation. AN EVEN QUICKER WAY is to TEST THE DRAIN WATER FOR CHLORINE. If no chlorine is detected, the drain water is a result of condensation.

Also take care to leave air inlet and exhaust passages free. Prevent exhaust air from immediately re-entering the unit through the inlet.

## 6.4 Maintenance

- √ Check the water inlet and drainage often. The water and air inflow into the system should be sufficient so that its performance and reliability does not get compromised. You should clean the pool filter regularly to avoid damage to the unit caused by clogging of the filter
- √ The area around the unit should be spacious and well ventilated. Clean the sides of the heat pump regularly to maintain good heat exchange and to save energy
- √ Check if all processes in the unit are operational and pay special attention to the operation pressure of the refrigerant system
- √ Check the power supply and cable connections regularly. Should the unit begin to function abnormally or should you notice a smell from an electrical component, arrange for timely repair or replacement
- √ You should also purge the water if the unit will not work for an extended period of time
- √ You should check all parts of the unit thoroughly and completely fill the system with water before turning it on again afterwards.

## 7.1 Trouble shooting

**Attention! Do not attempt to modify the internal configuration of the heat pump.**

- Keep your hands and hair clear of the fan blades to avoid injury.
- Do not attempt to modify the internal configuration of the heat pump.
- Do not attempt to adjust or service without consulting your dealer or your professional pool or air conditioning contractor
- Read the entire installation and user manual before attempting to use, service or adjust the unit
- Start the heat pump at least 24 hours after its installation in order to prevent damage to the compressor
- Switch off the power prior to maintenance or repairs.

**Attention! Switch off the power prior to maintenance or repairs.**

Problem:	the heat pump doesn't work	
Observation:	the screen does not light up and the fan/compressor doesn't make a sound	
Possible cause	Solution	
No electrical power supply	Check power supply (wiring, fuses,.....)	

Problem:	the heat pump works normally but there is no or insufficient heating	
Observation:	The screen displays the temperature but no error codes	
Possible cause	Solution	
1. In sufficient capacity of the heat pump in proportion to the size of the swimming pool	1. Install a larger sized model or an extra heat pump. Cover the pool to limit heat loss	
2. The compressor works but the fan doesn't	2. Check the electrical wiring of the fan. Replace the condenser or the fan motor if necessary.	
3. The fan works but the compressor doesn't	3. Check the electrical wiring of the compressor. Replace the condenser or the compressor if necessary.	
4. The heat pump has not been placed on an optimal location	4. Make for sufficient air circulation(see manual for details)	
5. Faulty temperature setting	5. Set the correct temperature	
6. By-pass not adjusted	6. Have the by-pass readjusted by the installer	
7. Massive ice formation on the evaporator	7. Have the settings for automatic defrost control checked by the installer	
8. Not enough refrigerant	8. Have the heat pump checked by a refrigeration technician	

Problem:	The heat pump works normally but the water is cooling down instead of heating up	
Observation:	The screen displays the temperature but no error codes	
Possible cause	Solution	
1.The wrong mode has been selected	1.Verify the parameters, select the correct mode	
2. The controller is out of order	2. Check the voltage in the electrical wiring to the 4-way valve. If no electric potential is measured, replace the controller	
3. The 4-way valve is out of order	3. Check the voltage in the electrical wiring to the 4-way valve. If electric potential is measured, replace the coil. If the problem persists, have the heat pump checked by a refrigeration technician	

<b>Problem:</b>	the heat pump doesn't stop	
<b>Observation:</b>	the screen displays the temperature but no error codes	
<b>Possible cause</b>	<b>Solution</b>	
1. Wrong setting of parameters	1. Check the set parameters and adjust them if necessary (settings just above the capacity of the heat pump)	
2. Pressure switch out of order	2. Check operation of the pressure switch by turning off the filter pump and restarting it. If the heat pump doesn't react to this, the pressure switch must be adjusted or replaced.	
3. Electrical failure	3. Contact your installer	

<b>Problem:</b>	water leak	
<b>Observation:</b>	there's an amount of water under the heat pump	
<b>Possible cause</b>	<b>Solution</b>	
1. Condensation due to atmospheric humidity	1. No action required	
2. Water leak	2. Try to localize the leak and check for the presence of chlorine in the water. If that is the case, the heat pump must be temporarily replaced during repair.	

<b>Problem:</b>	abnormal amount of ice formed on the evaporator	
<b>Observation:</b>	the evaporator is for the most part covered in ice	
<b>Possible cause</b>	<b>Solution</b>	
1. Insufficient air inflow	1. Check the location of the heat pump and remove any dirt that could be present on the evaporator	
2. High water temperature	2. If the pool water is already quite hot (warmer than 29?), the probability of ice formation increases. Lowering the set temperature is a possible option	
3. Incorrect setting of automatic defrost control	3. Check the setting of the defrosting function together with your installer.	
4. The 4-way valve is out of order	4. Check the voltage in the electrical wiring to the 4-way valve. If electric potential is measured, replace the coil. If the problem persists, have the heat pump checked by a refrigeration technician.	
5. Not enough refrigerant	5. Have the heat pump checked by a refrigeration technician.	

### 5.3 Failure code table for plug-in type PCB single system (4 cables)

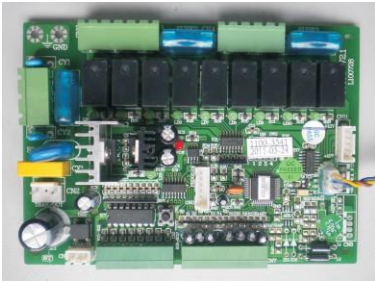

Wire controller	Protection/Failure	Check	Solution
PP01/PP1	Inlet water temp. sensor failure	1. Check the connection of inlet water sensor. 2. Check if the sensor is broken.	1. Reconnect the sensor. 2. Replace the sensor.
PP02/PP2	Outlet water temp. sensor failure	1. Check the connection of outlet water sensor. 2. Check if the sensor is broken.	1. Reconnect the sensor. 2. Replace the sensor.
PP03/PP3	Coil 1 temp. sensor failure	1. Check the connection of coil 1 temperature sensor. 2. Check if the sensor is broken.	1. Reconnect the sensor. 2. Replace the sensor.
PP04/PP4	Coil 2 temp. sensor failure	1. Check the connection of coil 2 temperature sensor 2. Check if the sensor is broken.	1. Reconnect the sensor. 2. Replace the sensor.
PP05/PP5	Ambient temp. sensor failure	1. Check the connection of ambient temperature sensor. 2. Check if the sensor is broken.	1. Reconnect the sensor. 2. Replace the sensor.
PP06/PP6	Protection for excessive temp. difference between water inlet & outlet	1. Check if there is any jam in the water circuit. 2. Check if the water flow volume is enough. 3. Check if the water pump has failed to work.	1. Remove the jam. 2. Increase the water flow volume. 3. Repair or replace the water pump.
PP07/PP7	Anti-freeze protection for cooling	Refer to PP06.	
PP07/PP7	Winter anti-freeze protection I	No action required	Refer to PP06.
PP07/PP7	Winter anti-freeze protection II	No action required	
PP08/PP8	Return gas temp. sensor failure	1. Check the connection of Return gas temp. 2. Check if the sensor is broken.	1. Reconnect the sensor. 2. Replace the sensor.
EE01/EE1	High pressure protection in system 1	1. Check if high pressure switch is broken. 2. Check if there's jam in water circuit or water flow not enough.	1. Replace new pressure switch. 2. Adjust less water flow.
EE02/EE2	High pressure protection in system 2	3. Check if refrigerant circuit jam.	3. Send heat pump to dealer for detailed check.
EE03/EE3	Water flow switch failure	1. Check if wiring connection of flow switch is in position. 2. Check if enough water flow. 3. Check if flow switch is broken. 4. Check if water pump failure.	1. Reconnect the wiring. 2. Increase enough water flow. 3. Replace flow switch. 4. Repair or replace water pump.
EE04/EE4	Order of phases incorrect	Order of phases incorrect	Reconnect the phases in right order
EE05/EE5	Failure of over-big temp. difference between water inlet & outlet	1. Check if there is enough water flow volume. 2. Check if inlet / outlet water temp. sensor failure.	1. Adjust bigger water flow. 2. Replace related sensor.
EE06/EE6	Low pressure protection in system 1	1. Check if high or low pressure switch is broken. 2. Check if lack of refrigerant.	1. Replace new pressure switch. 2. Charge enough refrigerant.
EE07/EE7	Low pressure protection in system 2	3. Ambient temp. and water inlet temp. is too low.	3. Remove jam or adjust bigger water flow.
No display	Defrosting		
EE08/EE8	Communication failure	Check the connection	Reconnect the connection wire.

# 8.1 Wiring Diagram ZWPA7.8 – 9.5 – 12.5H1F (220-240V)

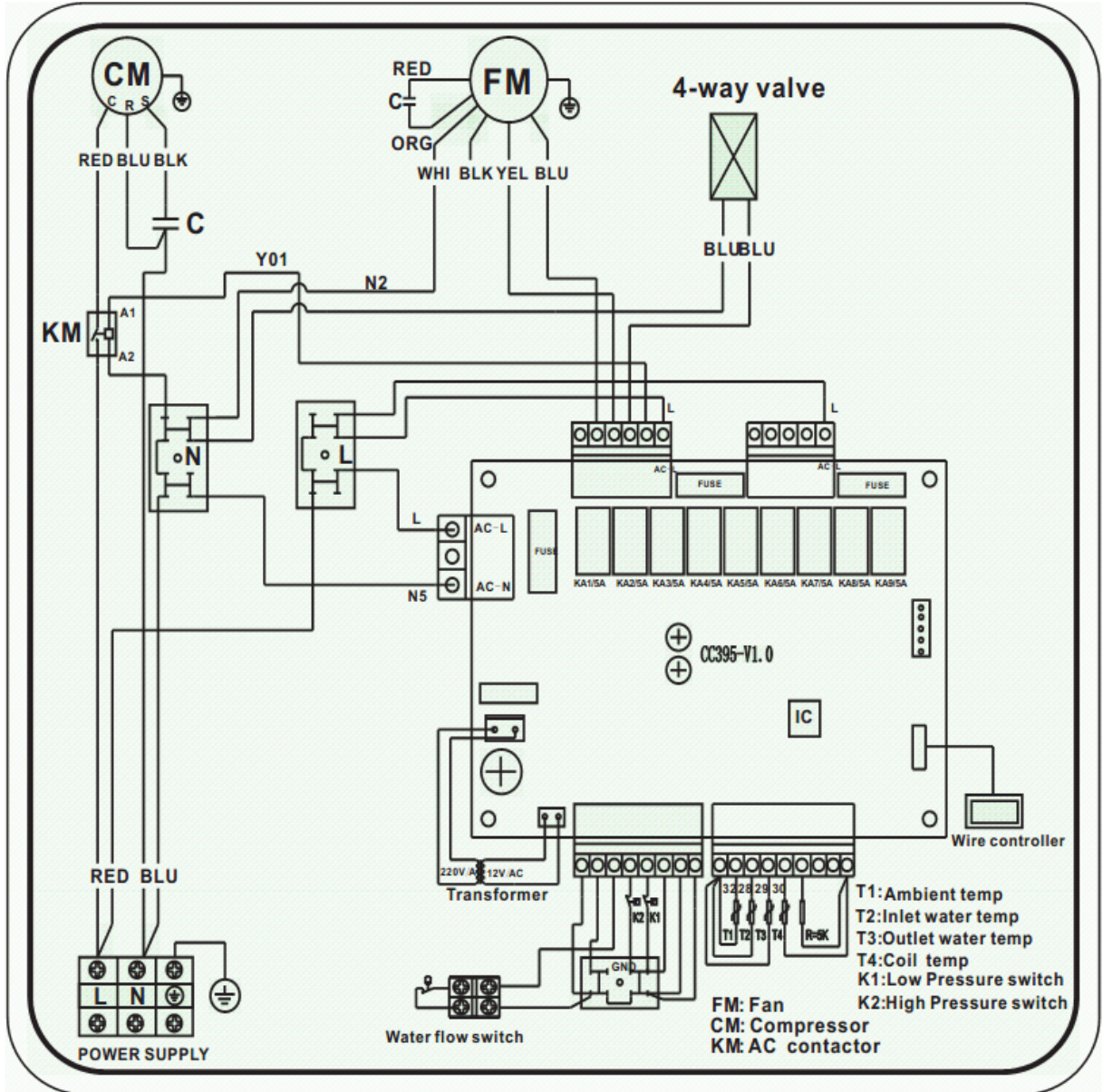



## 8.2 Wiring Diagram ZWPA 17.0 H1F (220-240V)

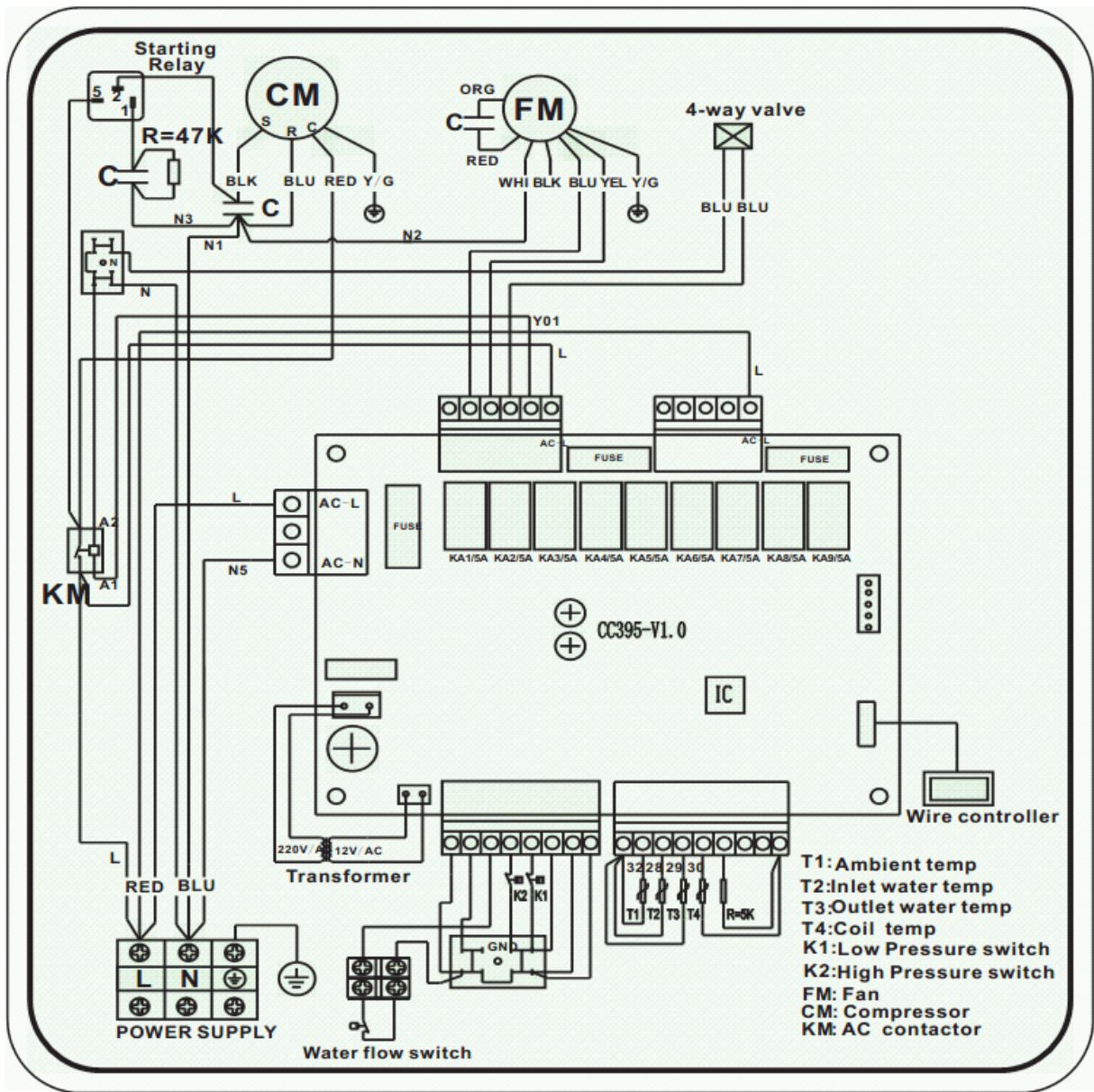

### 8.3 Wiring Diagram ZWPT 17.0 – 21.0 H3P (380-400V)

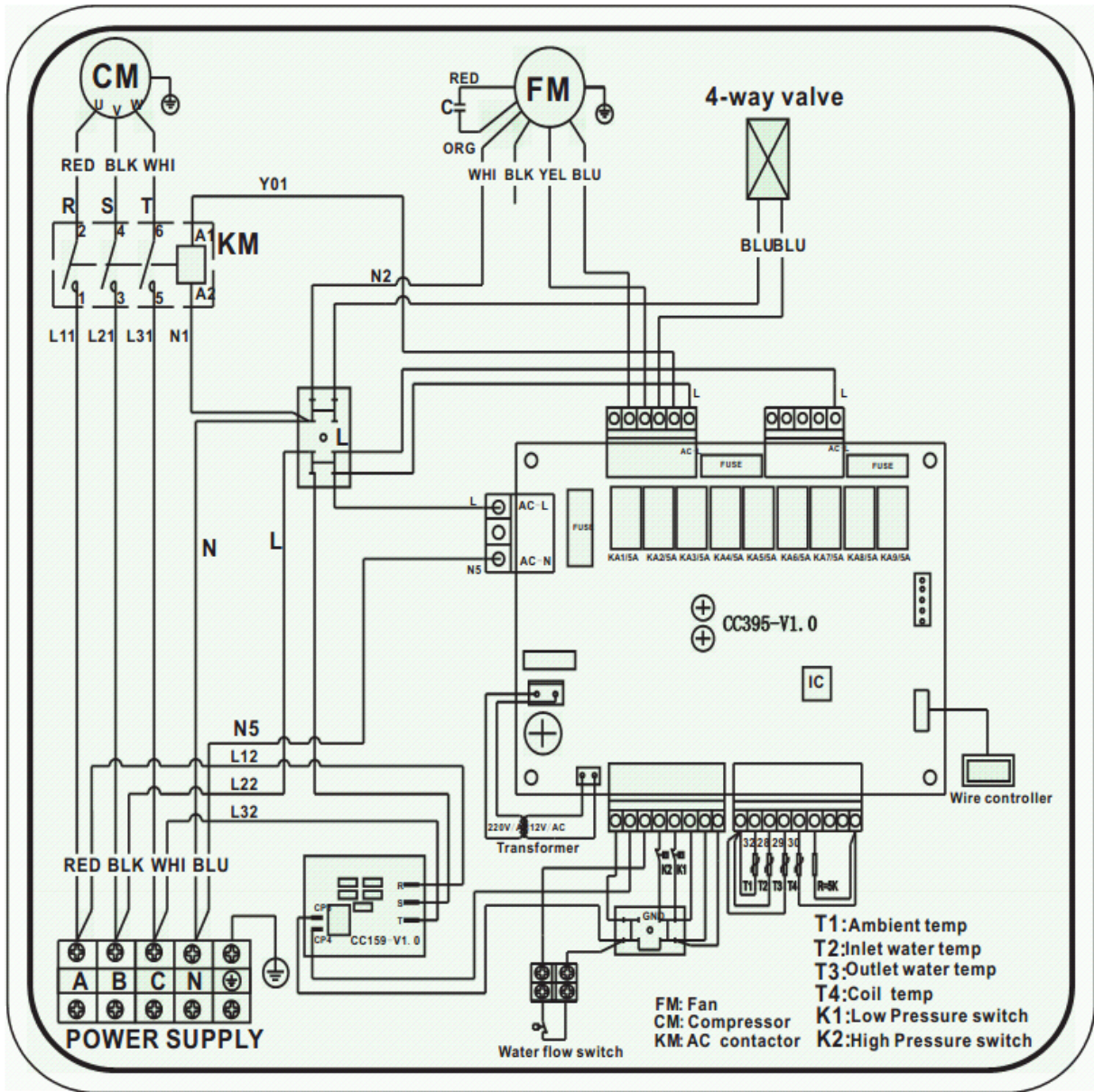



### 8.4 Wiring Diagram ZWPT 26.0 H3P (380-400V)

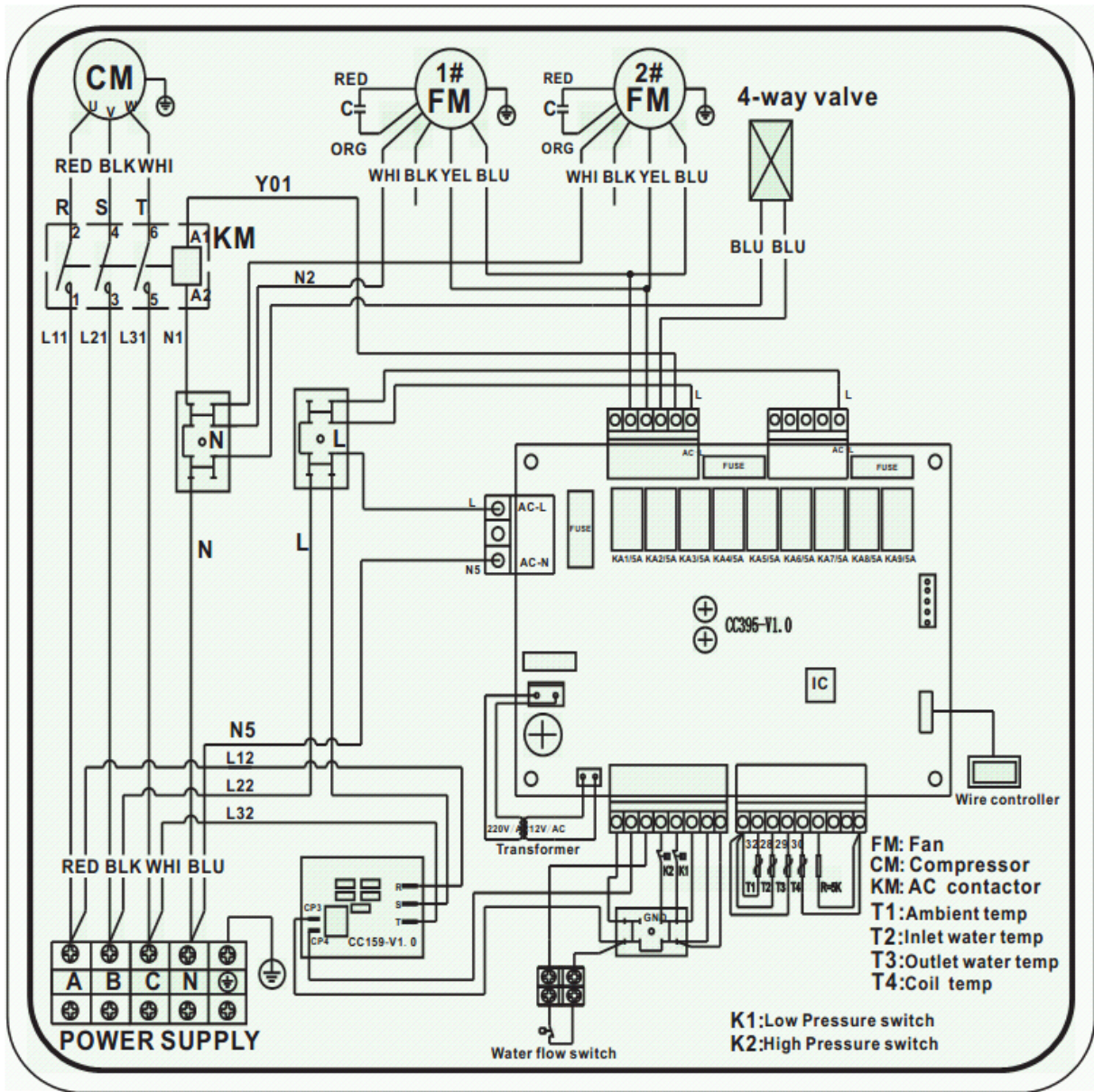







Storingsaanname formulier Zwembad warmtepomp			Datum:	
Klant:				
Contactpersoon:				
Tel. nr.				
Email.				
Product	<b>Model</b>	<b>Type</b>	<b>Voeding 230V of 380V</b>	
	VBK			
	SHPK			
	ZWPA			
	ZWPT			
	Anders:			
<b>Type VBK</b> Groene Condensor Groen LED Display	LED display EE.		Code:	
	Protect 300 EE		Signaal:	
<b>Type SHPK</b> Gold-fin condensor Kleuren LED-Display	LED display EE.		Code:	
			Signaal:	
<b>Type ZWPA/T</b> Gold-fin condensor Kleuren LED-display	LED display EE.		Code:	
			Signaal:	
<b>Omschrijving storing:</b>				
Manometer - Stand aflezen	Ja/Nee	Stand	..... bar	.....°C
Pomp draait - flowschakelaar schakelt	Ja/Nee			
Ventilator draait	Ja/Nee			
Parameterlijst gecontroleerd	Ja/Nee			
Veldbekabeling gecontroleerd	Ja/Nee	Afzekering	..... A	Type .....
Springt aardlekschakelaar uit	Ja/Nee			
Hoe staat het toestel opgesteld	Ja/Nee	Grond/Dak of anders nl.		
Kan de ventilator vrij uitblazen	Ja/Nee	Min. Afstand 1,5m		
Bediening op toestel	Ja/Nee			
WIFI card gemonteerd en actief	Ja/Nee			
Netwerkverbinding aanwezig	Ja/Nee			
<b>Opmerkingen</b>				

Deze handleiding is met de grootst mogelijke zorg samengesteld. Desondanks kunnen er ten alle tijde wijzigingen doorgevoerd worden aan het product en de bijbehorende technische specificaties. Derhalve zijn zet- en drukfouten voorbehouden. In gevallen waar de gegevens op de kenplaat van de warmtepomp afwijken van de gegevens in deze handleiding, dient u altijd de gegevens op het toestel te volgen. Aan de gegevens in deze handleiding kunnen geen rechten worden ontleend.